

---

# **Wind Turbine Generator**

**FA**

**Owner's Manual**

**Installation Operation Maintenance**

**CE & TUV**

### **Important Safety Instructions**

#### **READ THESE INSTRUCTIONS BEFORE ASSEMBLING, INSTALLING OR OPERATING YOUR PRODUCT.**

1. SAVE THESE INSTRUCTIONS. This manual contains important instructions that must be followed during assembly, installation and maintenance.
2. Read, understand and respect all warnings.
3. Do not install wind turbine on a windy day.
4. If unusual noise or operation is experienced, turn off machine and contact authorized service personal.
5. During assembly and installation properly torque all fasteners.
6. Use only proper grounding techniques as established by the NEC.
7. Wind turbine codes. Failure to comply with manual and local codes may affect and possibly void your warranty.
8. Rotating blades are a serious mechanical hazard. Install wind turbine so no one can come into contact with blades.

## FA series Technical Specifications

Model	FA1.2-200	FA1.2-300	FA1.2-400
Rated Power(W)	200	300	400
Rated Voltage(V)	12/24	12/24	12/24
Rotor diameter(M)	1.2	1.2	1.2
Start up wind speed(M/S)	2.5	2.5	2.5
Body	Die-casting aluminum		
Blades	3/5PCS Carbon fiber composite, 3/5PCS composite material		



### Connection with the tower fan: Fan set in the tower or poles

Tower or pole top is made of 48mm thickness of 4.0 OD, reserve height 80mm

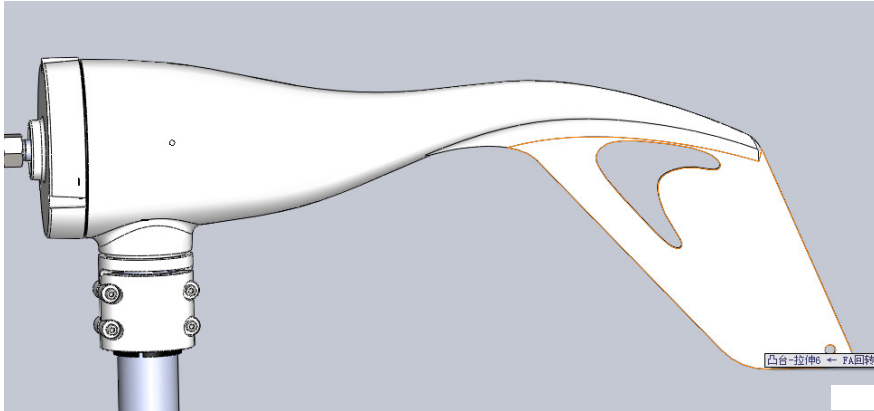

### Installation Steps:

#### 1. Unpacking Check

According to the following table to check the box interior parts are complete, in order to ensure the normal assembly

Item	Description	Qty
1	generator	1
2	Blade	3
3	hub	1
4	cover	1
5	Fastening piece	1
6	controller	1

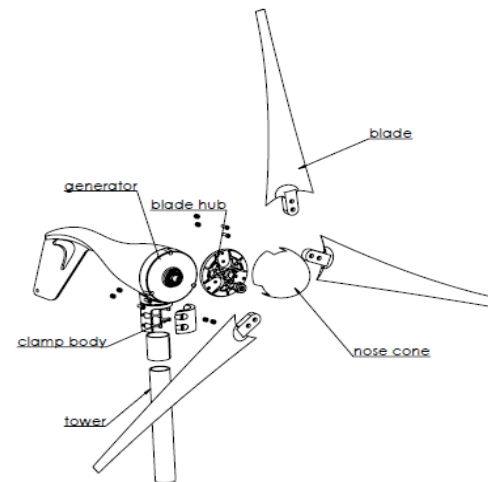

## 2. Wind turbine installation steps

- (1) The tower diagonal (diagonal angle easy to install wind turbines is appropriate); wear three cables, the cable from the tower pole square hole leads;
- (2) The wind turbine tower strongly loidiasis with two lines connected with insulating tape wrapped well and good along the cable into the tower, the tower of the generator sets with the casing, with 5mm Allen wrench screw locking

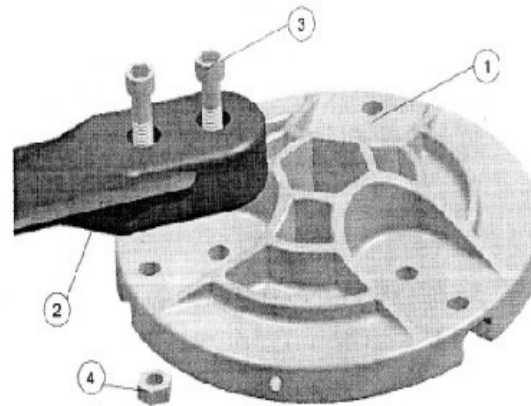
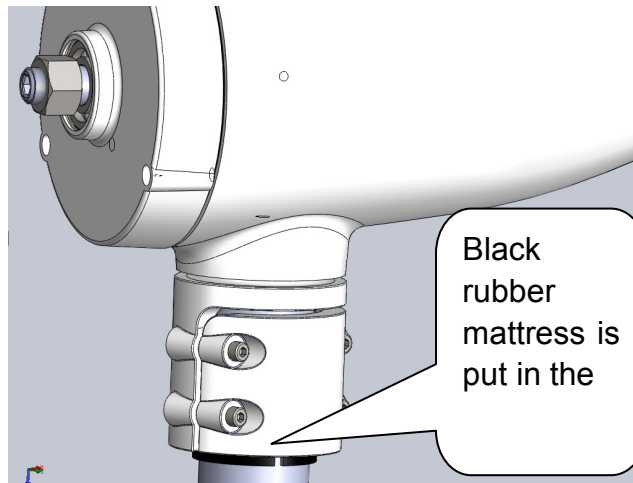

- (3) Install blades, blade (2) mounted on the flange (1), note the blades are literally facing outwards, with the M6 \* 20 (3) Allen screws and self-locking nuts M6 blade with flange connection, self-locking nut secured to the flange groove with 6mm hex wrench pre-locking (mounting direction shown in Figure 3), this method will be another two blades fixed on the flange, adjust the two tip distance error 5.0mm or less and then tighten the bolts to ensure that the fan balancing

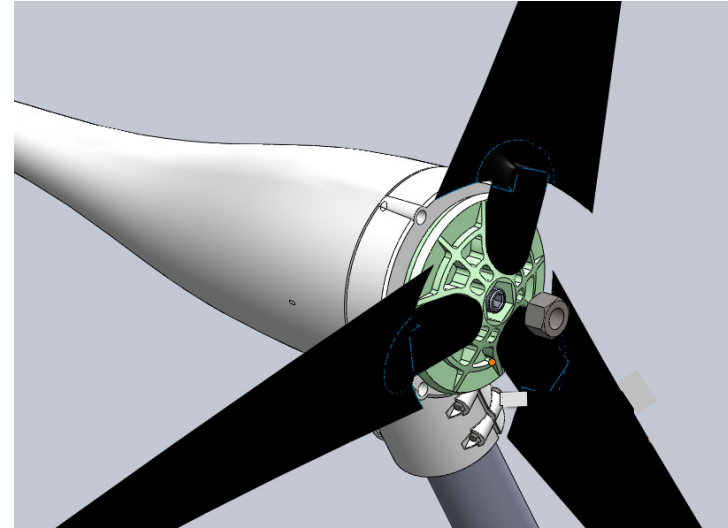
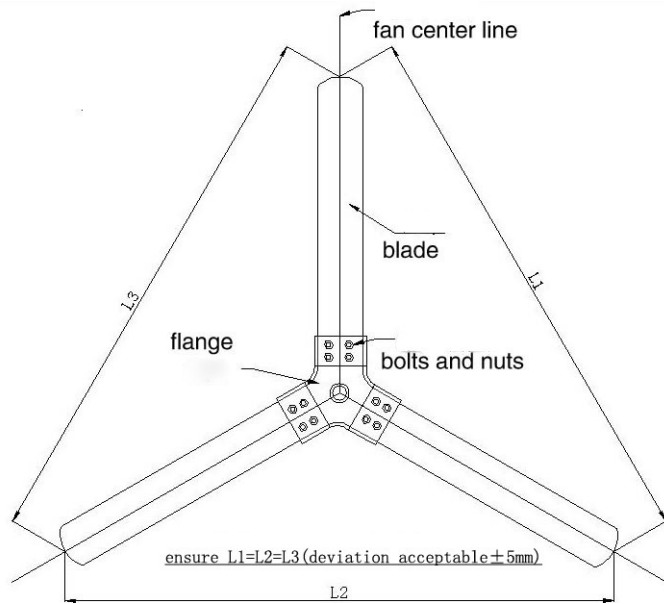

(4) Remove the M16 nut on the fan will step (3) finished sets and fan rotor shaft, and then install the flange nut groove, with 8mm hex wrench into the hexagonal hole in the middle of the rotor shaft, rotor shaft counterclockwise rotation its locking

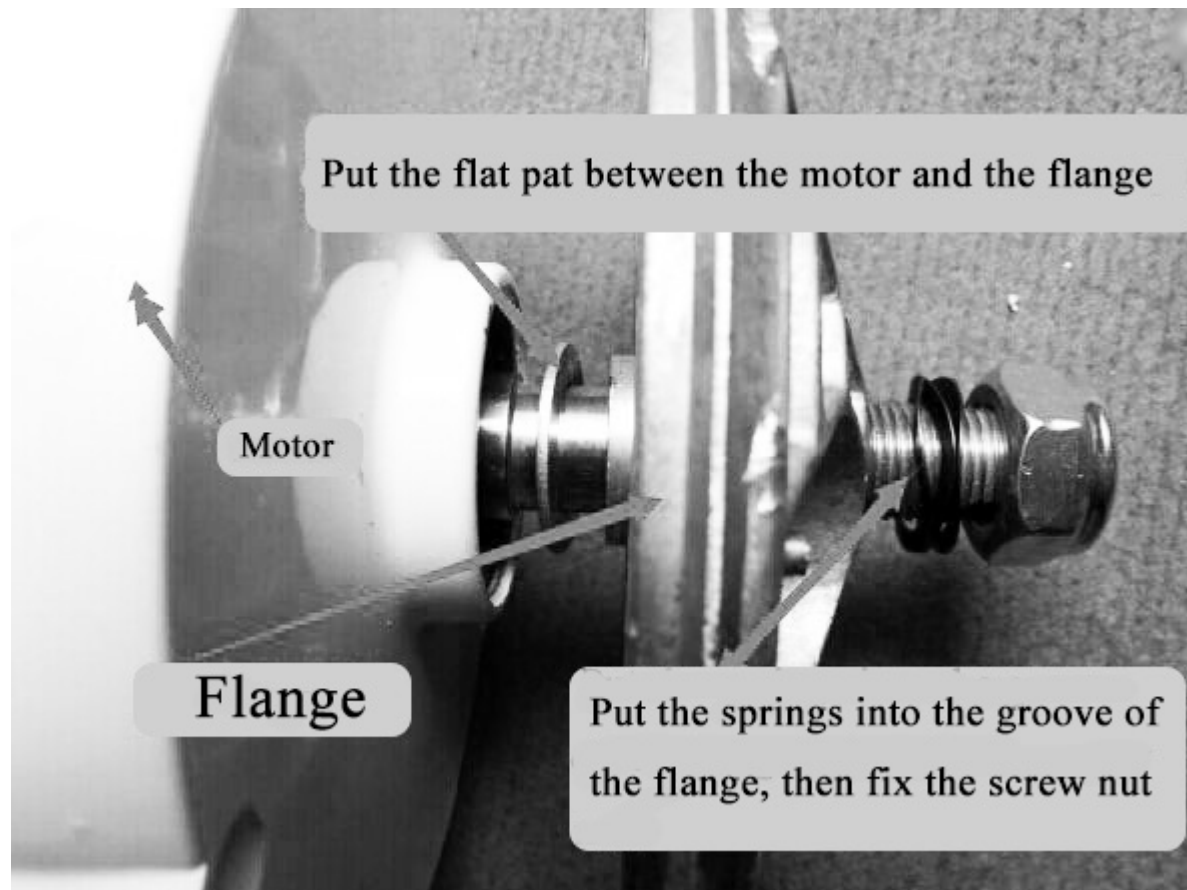

(5) Install cover, the cover buckle shown in Figure 6 on the flange, hand pull hood checks on the flange is fully charged to avoid falling off the hood at high speed (see photo below)

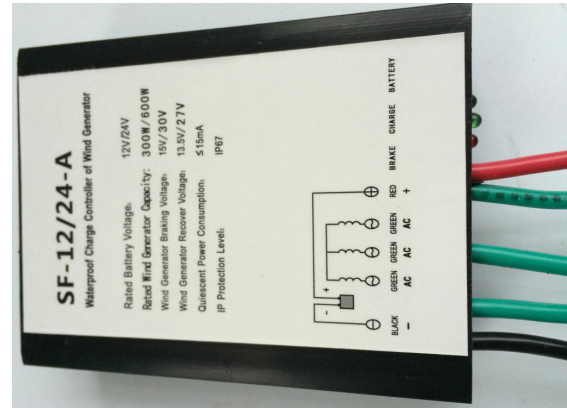
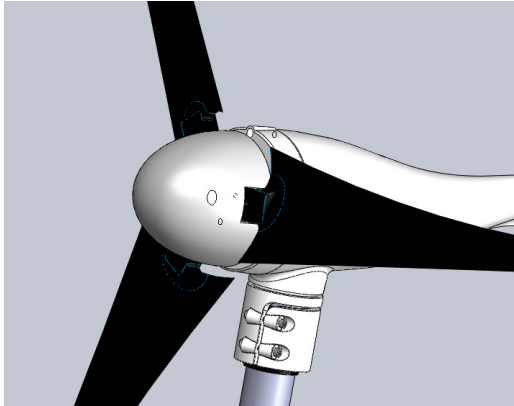

(Wind Charge Controller)

(6) Tower mounting, installation, ensure that the vertical and horizontal tower error 0.5 degrees or less

### 3. Wind Generator Charge Controller:

Remarks: The output of wind turbine generator is three phase AC, which connect to three green wires of controller, please don't distinguish the sequence, the red wire and black wire connected to battery " + " and " - ", this controller is 12v/24v automatically distinguish (See photo above)



---

## Maintenance:

Although your wind turbine has been designed to run for long periods without requiring any maintenance, reliability and performance will be enhanced if you periodically inspect your system.

CAUTION: Never approach the turbine during operation.

- Please make sure connect wind turbine to controller and battery at same time.
- After blades for chips or nicks. Replace blades if damaged. Do not operate the turbine with chipped or unbalanced blades. This can cause severe wear, damage, and possible failure. Do not install individual blades. The blades are balanced as sets.
- Check the blade bolts and the hub but for tightness.
- Check nosecone for cracks and proper fit.
- Wash off any built-up dirt or debris from the blades.
- Check all electrical connections to make sure they are tight and free from corrosion.
- As with all charging systems, check your battery water levels and add distilled water in accordance with manufacture's recommendation.
- We suggest replacing the blades and bearing every five years for optimal performance.

## Trouble clearing

The power generation system design is extremely demanding, under normal installation and use do not usually fail. Under special circumstances, please refer to the following table:

malfunction	Failure causes	Exclusion method
Fan vibration	<ol style="list-style-type: none"> <li>1. Rope loose</li> <li>2. Fixed blade bolts loose</li> <li>3. Wind turbine blades by external defect</li> <li>4. Imbalance caused by blade attachments</li> </ol>	<ol style="list-style-type: none"> <li>1. Adjust the tension rope</li> <li>2. Tighten loose part</li> <li>3. Replace blades</li> <li>4. Clear attachments</li> </ol>
Abnormal murmur	<ol style="list-style-type: none"> <li>1. Loose fasteners</li> <li>2. Alternator bearing damage</li> <li>3. Wind wheel and other parts of the friction</li> </ol>	<ol style="list-style-type: none"> <li>1. Tipped fan bracket, check all parts</li> <li>2. Replace bearings</li> <li>3. Examination to exclude</li> </ol>
Significantly reduced rotor speed	<ol style="list-style-type: none"> <li>1. Generator stator and rotor friction</li> <li>2. Stator winding short circuit or output short circuit</li> <li>3. Switch is in the down position controller</li> </ol>	<ol style="list-style-type: none"> <li>1. Replace bearing</li> <li>2. Short positions will be insulated</li> <li>3. Power switch set to the position controller</li> </ol>
Generator output voltage is low	<ol style="list-style-type: none"> <li>1. Motor speed low</li> <li>2. Three-phase short circuit in stator winding</li> <li>3. Controller circuit</li> <li>4. Low-voltage transmission line is too long or too small</li> </ol>	<ol style="list-style-type: none"> <li>1. Identify the reasons for return to positive production speed</li> <li>2. Short positions will be insulated</li> <li>3. Replace controller</li> <li>4. Shorten lines, bold diameter</li> </ol>
No output generator AC line	<ol style="list-style-type: none"> <li>1. Output line circuit</li> </ol>	<ol style="list-style-type: none"> <li>1. Identify the reasons, turn circuit</li> </ol>
Motor AC output normal But no DC output	<ol style="list-style-type: none"> <li>1. DC blown fuse</li> <li>2. Output line circuit</li> <li>3. Controller rectifier damage</li> </ol>	<ol style="list-style-type: none"> <li>1. Replace the fuse</li> <li>2. Identify the reasons, turn circuit</li> </ol>
Battery output capacity is insufficient	<ol style="list-style-type: none"> <li>1. Generator output voltage is too low</li> <li>2. Poor conductivity battery posts</li> <li>3. Battery failure</li> </ol>	<ol style="list-style-type: none"> <li>1. Excluded by the above examinations</li> <li>2. Maintenance batteries</li> </ol>